

dCS Vivaldi DAC
Stereo Digital to Analogue Converter

User Manual
Software Release 2.1x
July 2019

This product incorporates the following *dCS* proprietary technology:

Ring DAC™

Part No.: DCS400659 V01

© **Data Conversion Systems Ltd. 2012-2019**

All rights reserved. No part of this publication may be reproduced, stored in or introduced into a retrieval system, or transmitted in any form, or by any means (electronic, mechanical, photocopying, recording or otherwise) without the prior written permission of *dCS*¹. Any person who does any unauthorised act in relation to this publication may be liable to criminal prosecution and civil claims for damages.

Information contained in this manual is subject to change without notice, and whilst it is checked for accuracy, no liabilities can be accepted for errors.

¹ *dCS* is Data Conversion Systems Ltd. Company registered in England No. 2072115.

Contents

Using the dCS Vivaldi DAC for the first time	5
What's in the box?	5
dCS Mosaic	5
Positioning the unit	6
Important Safety Instructions	6
Safety Notice	7
Step-by-Step Guide	8
Preliminaries	8
STEP 1 – Connecting a PCM Input	9
Connecting to a Dual AES Source	9
Connecting to a Single AES or SPDIF source	10
Connecting to an SDIF/DSD Source	10
STEP 2 – Setting up the USB source	11
Compatibility	11
Connecting the USB interface	11
Loading the Windows driver for USB Class 2	11
Basic setup with a PC	12
A word about Music Playing Software	12
Selecting the Vivaldi DAC as your Audio Output device	13
STEP 3 – Connecting the Analogue Outputs	14
STEP 4 - Setting the Output Level	14
STEP 5 – Choosing a Sync Mode	15
Using the DAC's AES & SPDIF inputs in Master Mode	15
Using a Master Clock in a CD/SACD system	16
A full Vivaldi system	17
Advanced options	19
Customising the input configuration	19
Playing MQA files	20
Front Panel	21
Remote Control Receiver	21
Display	21
Power Button	22
Menu Button	22
Filter Button	22
Input button	23
Mute Button	23
Rotary Control	24
Rear Panel	25
Analogue Outputs	25
AES Digital Inputs	25
SPDIF Digital Inputs	26
SDIF-2 Digital Interface	26
USB Interface	26
Word Clock Inputs and Output	27
Test interface	27
Mains inlet	27
Label	27
The Menu	28
Using the Menu	29
INFORMATION Menu	30
Unit Status	30
Version	30
Contact	30

Update	30
SETTINGS Menu	31
Mapper	31
Sync Mode	31
Output Level	32
Dual AES1+2	32
Dual AES3+4	32
Phase	32
Channel Swap	33
Balance	33
USB Class	33
Buffer	33
EasyPlay	34
RS232 Mode	34
CONFIGURATION Menu	35
Settings Lock	35
Save Configuration	35
Restore Configuration	35
Reset Input Names	35
Factory Reset	35
DISPLAY SETTINGS Menu	36
Brightness	36
Display On/Off	36
GENERATOR Menu	36
Channel Check	36
Phase Check	36
Burn In	36
Specification	37
Maintenance and Support.....	39
Service and Maintenance	39
Replacing a Blown Mains Fuse	39
Cleaning the case	39
Limited Warranty	40
If you need more help	41
Software History	42
Index	43

USING THE *dCS* VIVALDI DAC FOR THE FIRST TIME

Congratulations on purchasing your *dCS* Vivaldi DAC.

Before using your unit, please read this section and the Step by Step Guide. This will enable you to set the unit up quickly and safely with your hi-fi system.

From time to time, *dCS* will release updated software that you can install yourself using the **Update** feature. Please check our web-site occasionally to see if new Vivaldi DAC software is available, or consult your dealer.

What's in the box?

Check that the box contains the following items:

- *dCS* Vivaldi DAC
- Manual and Menu / Setup Guide
- Power cable
- 2 AES/EBU cables
- BNC cable
- USB cable
- 2 spare fuses
- *dCS* Universal Remote Control Handset with 2x AAA batteries

Notify your dealer as soon as possible if anything is missing or damaged. We suggest that you retain the original packaging for possible future use. If this is not possible, replacement packaging can be ordered from *dCS* or our distributors. Details can be found on our web site at www.dcsLtd.co.uk.

dCS Mosaic

dCS Mosaic is a carefully assembled collection of hardware and software modules which provide easy and intuitive access to a vast catalogue of digital music. Whether it's high resolution files on a local server or an internet radio station broadcast from a distant land, *dCS Mosaic* ensures that the music you love is only a few convenient taps away. *dCS Mosaic* comprises of three parts.

The *dCS Mosaic Control* app operates through the Vivaldi Upsampler Plus to provide control of the Vivaldi DAC settings over a network. You will see references to the **Mosaic Control** paths throughout this manual. In order for the Upsampler to communicate with the DAC, they must be connected together by Dual AES and by the 3-way RS232 cable supplied with the Upsampler. Please see the Upsampler manual for more information.

Positioning the unit

For best sound quality, the units in the Vivaldi range are designed to be mounted on separate shelves of a rack, although they may be stacked directly on top of each other if this is absolutely necessary. Place each unit on a firm, vibration free base, allowing convenient connection to the other parts of your system. To prevent overheating, we recommend that you leave some free space around the unit to allow for ventilation.

The unit is supplied with 4 feet fitted. If you prefer a 3-feet layout, unscrew the two back feet, remove the two black cores using a 2.5mm A/F Allen key, fit one of the cores in the middle position and replace the foot. Take care not to cross-thread the foot!

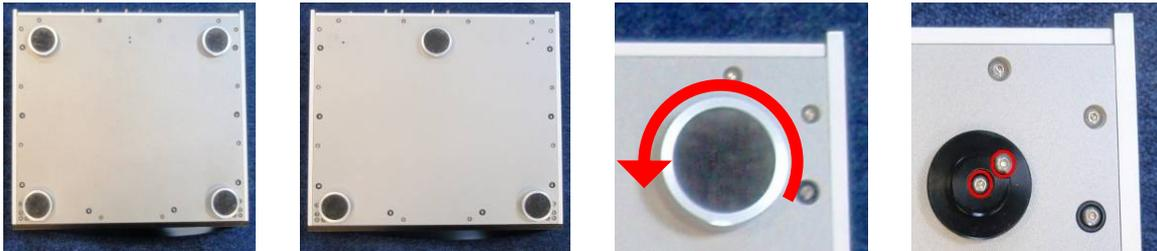

With all feet screwed fully home, the unit will sit level on a flat surface. If you need to do any levelling, you can unscrew any of the feet up to 3 complete turns, to give up to 3mm (1/8") of height adjustment.

Important Safety Instructions

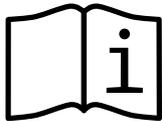

The following statements are required to comply with U.S. safety standard UL60065.

- Read these instructions.
- Keep these instructions.
- Heed all warnings.
- Follow all instructions.
- Do not use this apparatus near water.
- Clean only with dry cloth.
- Install in accordance with the manufacturer's instructions.
- Do not install near any heat sources such as radiators, heat registers, stoves, or other apparatus (including amplifiers) that produce heat.
- Do not defeat the safety purpose of the grounding-type plug. A grounding type plug has two blades and a third grounding prong. The third prong is provided for your safety. If the provided plug does not fit into your outlet, consult an electrician for replacement of the obsolete outlet.
- Protect the power cord from being walked on or pinched particularly at plugs, convenience receptacles, and the point where they exit from the apparatus.
- Only use attachments/accessories specified by the manufacturer.
- Unplug this apparatus during lightning storms or when unused for long periods of time.
- Refer all servicing to qualified service personnel. Servicing is required when the apparatus has been damaged in any way, such as power-supply cord or plug is damaged, liquid has been spilled or objects have fallen into the apparatus, the apparatus has been exposed to rain or moisture, does not operate normally, or has been dropped.

Safety Notice



In the event of the unit developing a fault, please contact your dealer in the first instance.

If you decide to remove safety covers for any reason, disconnect the power cable first. Note that removing covers voids the warranty.

To maintain protection from electric shock, the unit **MUST** be connected to mains earth (ground) via the power cable. Also, unearthed systems do not give the best sonic performance.

Protect the product from dripping or splashing liquids. Liquid-filled objects such as vases must not be placed on the product.



This product is not suitable for operation at altitudes above 2000m.



This product is lead-free and complies with the RoHS directive.

Before connecting the power cable to the unit for the first time, please check that it has been set to the correct operating voltage for your mains supply. The unit's voltage setting is shown on the serial number label. If this does not match your local supply voltage, **DO NOT** attempt to use the unit. Contact your dealer to have the unit reset. Using the unit with the wrong mains setting for your local supply may result in serious damage to the unit and will invalidate the warranty. Do not attempt to reset the voltage yourself.

We do not recommend the use of mains regenerators. However, if you do wish to use a mains regenerator with variable voltage and frequency, we recommend that you set the voltage to match your local voltage and the frequency to either 50Hz or 60Hz **ONLY**.



Damage caused to your Vivaldi DAC by misuse of a mains regenerator or by a malfunctioning mains regenerator is not covered by the warranty.



Disposal at end-of-life: the symbol indicates that this product should not be treated as normal household waste. It should be recycled, so please take it to an approved collection facility.

STEP-BY-STEP GUIDE

This section guides you through setting up the unit for basic operation.

Preliminaries

The Menu Guide sheet details the menu structure.

For digital interfaces, use with cables designed for digital audio:

- for AES/EBU interfaces use 110Ω screened, twisted pair cables fitted with one male XLR connector and one female XLR connector.
- for SDIF-2, Word Clock or SPDIF BNC interfaces, use 75Ω coax cables fitted with BNC plugs.



SDIF-2 and Word Clock interfaces require a simple DC-coupled connection. The interfaces may malfunction or not work at all if capacitor coupled cables or cables with built-in networks are used.

- for SPDIF RCA interfaces, use 75Ω coax cables fitted with RCA Phono plugs.
- for TOSLINK optical interfaces, use Toslink fibre-optic cables.
- for the USB interface, use a standard USB2.0 cable fitted with one type A and one type B connector. The internal screen must be connected at both ends.

For analogue outputs, use with screened cables of the correct type:

- for balanced outputs, use screened, twisted pair cables fitted with one male XLR connector and one female XLR connector.
- for unbalanced outputs, use coax cables fitted with RCA Phono plugs.

Connect the power cable to the power inlet on the DAC rear panel, plug the other end into a convenient power outlet.



Please do not use an excessively heavy or inflexible power cable as this may damage the power inlet connector.



The cables supplied with the unit are “commercial grade”, because most owners will have their own “audiophile grade” cables or will prefer to make their own cable choices.

Press the **Power** button – the unit will display **Vivaldi DAC**. Wait about 30 seconds while the DAC configures itself.

If the unit is likely to be set in an unfamiliar state, you can run the **Factory Reset** routine by pressing the buttons in this sequence: **Menu**, **▶**, **▶**, **Menu**, **◀**, **◀**, **Menu**.

Wait a few seconds while the unit resets itself.

Fit the batteries to the remote control handset as described in the remote guide.

STEP 1 – Connecting a PCM Input

If you want to use the USB input only, go to Step 2.

Switch on the source equipment. If appropriate, load a disk / tape and set the machine in PLAY mode to ensure it is generating a digital audio data stream.

Choose one or more of the following sections:

Connecting to a Dual AES Source

- Check that your source equipment (probably a dCS SACD Transport or a dCS Upsampler) is capable of Dual AES operation and is set up correctly.
- Connect the AES1 output on your source equipment to the **AES1** input on the DAC rear panel and the AES2 output to the **AES2** input, using two XLR cables. Ensure the cables are not swapped.
- Press the **Input** button repeatedly until **AES1+2** is displayed.

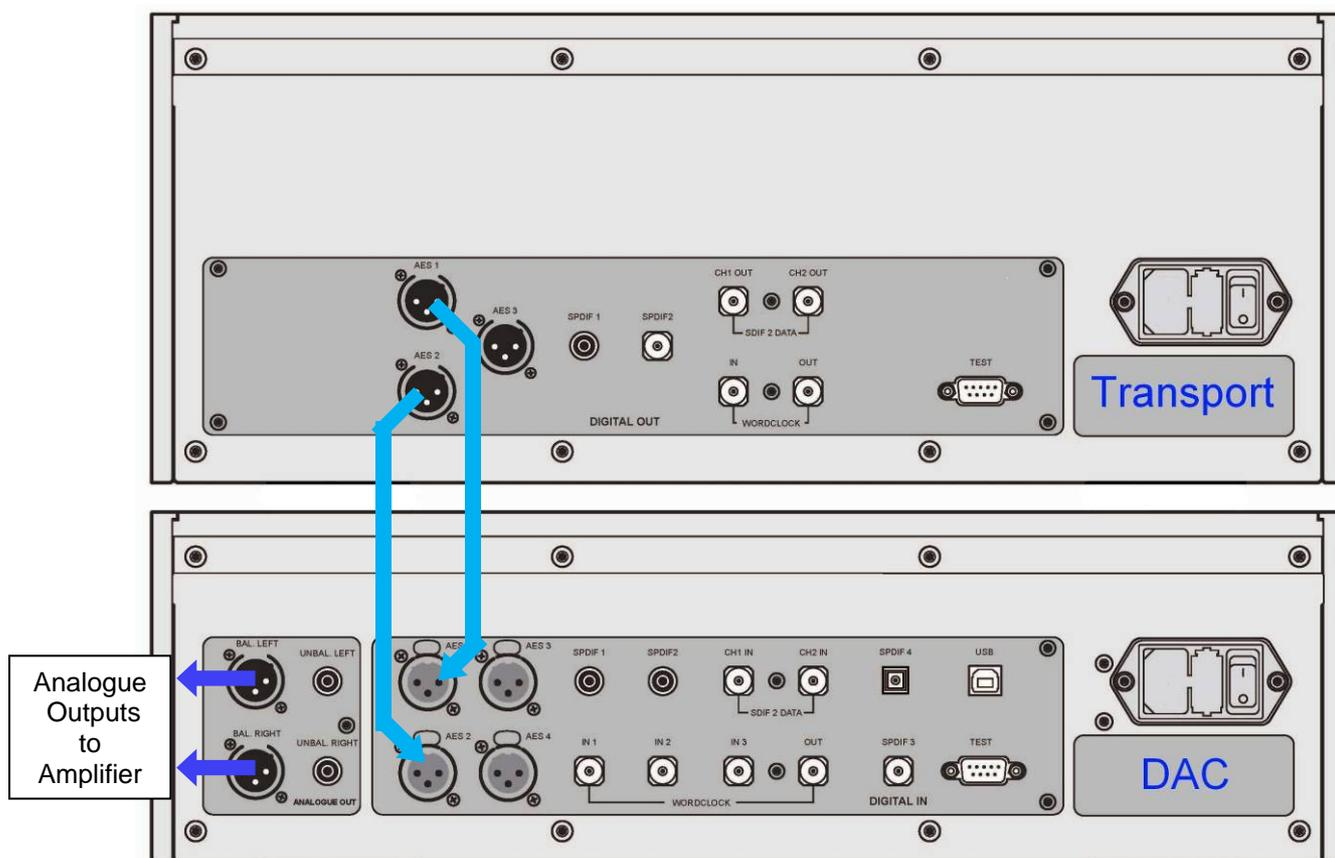

Figure 1 – Using the Vivaldi Transport with the DAC

The DAC will lock to the source, displaying **24/352.8** for example, if the source is generating 24 bit data at 352.8kS/s.

The Vivaldi DAC has a second Dual AES input on **AES3** and **AES4**. You can connect a second Dual AES source to these inputs and use the **Input** button to select **AES3+4**.

The most common set-up is to connect a Vivaldi Transport to **AES1+2** and a Vivaldi Upsampler to **AES3+4**.

Connecting to a Single AES or SPDIF source

Most source equipment (such as CD transports, DVD players) is fitted with a single wire digital output, usually on an RCA phono connector.

- Connect your source equipment to the matching input on the DAC rear panel using a suitable cable.
- Press the **Input** button repeatedly until your chosen input is displayed. This will be either **AES1**, **AES2**, **AES3**, **AES4**, **SPDIF1 (RCA)**, **SPDIF2 (RCA)**, **SPDIF3 (BNC)**, or **Toslink**.

The DAC will lock to the source, displaying **16/44.1** for example, if the source is a CD player.

Connecting to an SDIF/DSD Source

Check that your source equipment is capable of SDIF PCM or DSD operation.



SDIF (**S**ony **D**igital **I**nter**F**ace) is not the same as SPDIF (**S**ony/**P**hilips **D**igital **I**nter**F**ace) and the two are not compatible.

Please ensure that you connect to the correct BNC sockets.

- Connect the CH1 output on your source equipment to the **CH1** input on the DAC rear panel and the CH2 output to the **CH2** input, using two BNC cables. Connect the word clock output on your source equipment to one of the **Word Clock In**put connectors on the DAC rear panel.
- Ensure the cables are not swapped.
- Press the **Input** button repeatedly until **SDIF-2** appears on the display.



Set the **Settings > Sync Mode** menu page to **Word Clock 1, 2 or 3** as appropriate.

PCM or DSD mode is automatically detected. The DAC will lock to the source, displaying **16/44.1** for example, if the source is a CD player. **DSD** is displayed if the source is sending DSD data.

STEP 2 – Setting up the USB source

If you do not want to use a USB source, go to STEP 3.

Compatibility

The USB interface can be connected to Windows™ 10, Windows™ 8.1, Windows™ 7 (SP1), Mac™ OS X (10.5.4 or later) systems or a sound server, running music streaming software.

The interface should work with Linux Ubuntu servers and computers fitted with USB 2.0 interfaces that natively support USB Audio Class 1 or Class 2 operation, but this has not been extensively tested.

Connecting the USB interface

One of the USB Audio classes must be set during system set-up. The DAC is shipped set to USB Audio Class 2.

USB Audio Class 1: The interface operates without a special driver at up to 96kS/s.



To select Class 1, open the menu, navigate to the **Settings > USB Class** menu page. The button sequence is: **Menu**, **▶**, **Menu**, **◀**, **◀**, **◀**, **◀**, and then use the **Menu** button to select the Class 1 icon. Wait 10 seconds while the Class 1 code is loaded.

USB Audio Class 2: The interface operates at up to 384kS/s (including DSD/64 & DSD/128 over PCM).

For Mac OS X, version 10.11 or later is required.

For Windows, the *dCS* USB Class 2 Driver 2018 must be installed onto the computer before use (see below).



To select Class 2, open the menu, navigate to the **Settings > USB Class** menu page. The button sequence is: **Menu**, **▶**, **Menu**, **◀**, **◀**, **◀**, **◀**, and then use the **Menu** button to select the Class 2 icon. Wait 10 seconds while the Class 2 code is loaded.

Loading the Windows driver for USB Class 2

- If ASIO4ALL or any other ASIO driver (e.g. for a sound card) is loaded on your computer, please uninstall it - otherwise the *dCS* driver will not work correctly.
- Power up the DAC and the computer.
- Make sure the DAC is set to USB Audio Class 2 - otherwise the driver installation will fail.
- Connect the DAC's **USB** port to the computer's USB port.
- Go to <http://www.dcsLtd.co.uk/products/vivaldi-dac/support>, click the **Support** link, then click the **Download** button next to **USB Class 2 Driver 2018**.
- Unzip the file to a temporary directory and run the file.
- Follow the on-screen prompts.
- When prompted, connect the DAC's **USB** port to the computer's USB port.
- Wait until installation is complete, then re-start the computer.



If you connect a Vivaldi DAC set for USB Audio Class 2 to a Windows computer without first loading the driver, the computer will not be able to find the DAC.

Basic setup with a PC

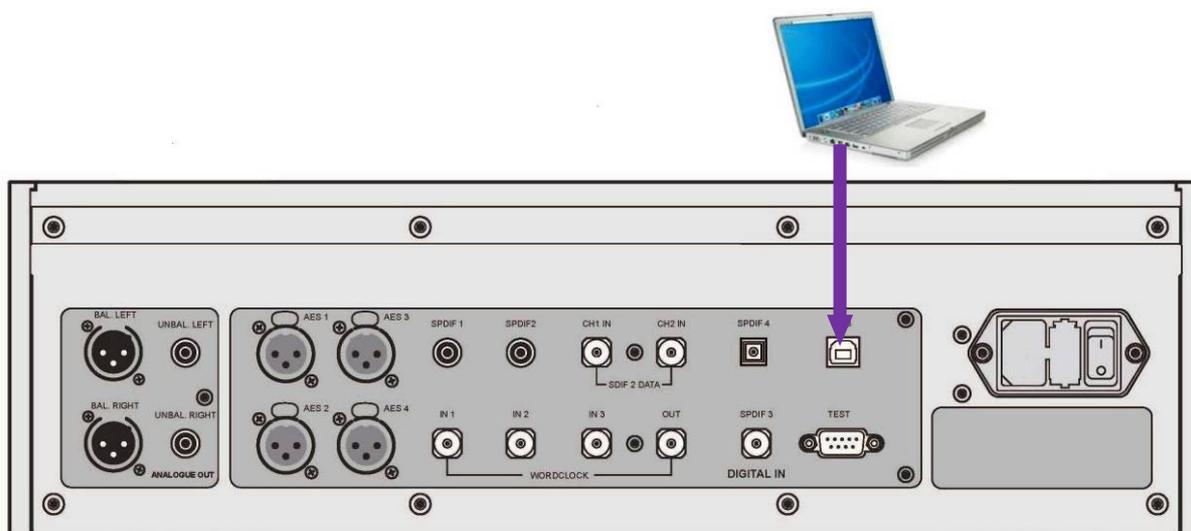

Figure 2 – Connecting the USB interface.

- Connect one of the computer's USB ports to the **USB** port on the DAC's rear panel.
- Press the **Input** button repeatedly until **USB** is displayed. If the source is transmitting PCM data, the DAC will lock to the source and the sample rate will be displayed.

The DAC's USB interface operates in asynchronous mode. This allows the clock inside the DAC to control the delivery of data from the computer, avoiding the use of the computer's inaccurate and jittery clock.

A word about Music Playing Software

There are countless programs that can play music on Windows™ PC and Apple Mac™ OSX systems. Unfortunately, not all of them present the data completely unprocessed to the USB ports. For example, Windows Media Player re-samples all data to 24 bits at the original sample rate, while iTunes converts data as necessary to the output sample rate set in the OSX Audio MIDI Set-up panel.

With such a proliferation of playing software, and updates being issued frequently, it is impossible for *dCS* to be fully up-to-date with the behaviour and performance of all programs. If you have questions or problems, we would urge you to take them up with your software vendor. What we will say is that different programs operate very differently and it is well worth finding out exactly how your particular program processes the audio.

We suggest that you use a premium music streaming program, such as JRiver Media Center (Windows or Mac) or Audirvana (Mac), rather than relying on the software bundled with the operating system.

Selecting the Vivaldi DAC as your Audio Output device

Whichever program you are using to play your music, your computer may not automatically select your Vivaldi DAC as the preferred playback device. You can correct this as follows:

Mac OSX™ - Open **Finder**, click on the **Go** tab and select **Utilities > Audio MIDI Setup**. Select **dCS Vivaldi...** from the list on the left-hand side, right-click on it, and choose **Use this device for sound output** from the drop down list. Set the **Format** to **384000.0Hz** and **2ch-24bit Integer**. Close **Audio MIDI Setup**.

Windows 10™ / Windows 8.1™ / Windows 7™ - Go to **Start > Control Panel > Sound**. In the **Playback** panel, right-click **dCS Vivaldi** or **dCS Vivaldi DAC Audio** and choose **Set as Default Communication Device**. Click the **Enhancements** tab and check **Disable all enhancements**. Select the **Advanced** tab, choose **24 bit, 384000 Hz (Studio Quality)** from the drop-down box. Check the 2 boxes under **Exclusive Mode**, click **OK** and **OK** again to close the **Sound** panel.



This is basic setup information.

Open your streaming program, select the **Vivaldi DAC** in the **Options** or **Preferences** panel and play some music.

STEP 3 – Connecting the Analogue Outputs

Choose one of the following two sections:

Using a preamplifier

- Set the preamplifier volume control to a low level.
- Connect either the balanced (XLR connectors) or unbalanced (RCA phono connectors) outputs on the DAC's rear panel to matching line level inputs on your preamplifier (probably labelled CD or AUX).
- Turn the DAC's rotary control clockwise to set the **Volume** to maximum (**-0.0dB** on the display).

Slowly increase the preamplifier volume until the music is at the right level.

Using a power amplifier directly

- Turn the DAC rotary control counter-clockwise to set the Volume to around -40.0dB as shown on the display.
- Connect either the balanced (XLR connectors) or unbalanced (RCA phono connectors) outputs on the DAC rear panel to matching inputs on your power amplifier. Switch on the power amplifier.
- Turn the DAC rotary control slowly clockwise until the music is at the right level.

Play some music, you should have audio.



The most common fault reported when using our balanced outputs is hiss, unstable levels and a thin sound on both channels. This is caused by connecting the DAC's balanced output stage to an unbalanced input on an XLR connector with pin 3 left unconnected. This does not work correctly with a balanced and floating output stage – you must connect pin 3 to pin 1 (ground) to complete the signal path.

Another possible cause of this fault (probably on one channel only) is a broken cable.



The Vivaldi DAC has independent balanced and unbalanced output stages, so you can connect them to different amplifiers if you wish.

STEP 4 - Setting the Output Level

If the preamplifier volume setting for a comfortable listening level is too high or too low, you may need to change the **Output Level** setting.



Setting the **Output Level** to **6V** can cause some preamplifiers to overload and distort. For this reason, we recommend the **2V** setting if a preamplifier is used.

Similarly, if you are driving a power amplifier directly and the DAC **Volume** setting for a comfortable listening level is higher than **-10.0** or lower than **-30.0** try changing the **Output Level** setting by pressing the buttons in this sequence: **Menu**, **▶**, **Menu**, **▶**, **Menu**.

If the setting is **2V** and the DAC **Volume** is still set well below **-30.0**, your power amplifier or loudspeakers must have a very high sensitivity. Try the **0.6V** or **0.2V** settings.

STEP 5 – Choosing a Sync Mode

So far, the system has been set up to lock to the clock generated by the source. If you are using the SDIF-2 interface, the DAC will lock to a word clock generated by the source. The basic Sync Mode for the USB interface is Master Mode because it is an asynchronous interface. This is the simplest arrangement, but it does not give the best sonic performance due to clock jitter.

If your source equipment has a word clock input, you may be able to reduce the jitter in your system by either setting the DAC to Master Mode or locking the system to a Master Clock. If not, you can miss out this section.



The **Sync Mode** setting must be set separately for each input that is used. This arrangement is necessary to allow a mixture of clocked and un-clocked sources to be used in the same system.

Using the DAC's AES & SPDIF inputs in Master Mode



You can use Master Mode ONLY if your source equipment can lock to a 44.1kHz word clock and the DAC is receiving data at 44.1, 88.2, 176.4 or 352.8kS/s or DSD. If the system is not set up correctly and fails to lock, you will hear clicks / noises from the speakers and the signal may be distorted.

- Connect the equipment as shown, taking special care to connect the clock cable correctly.

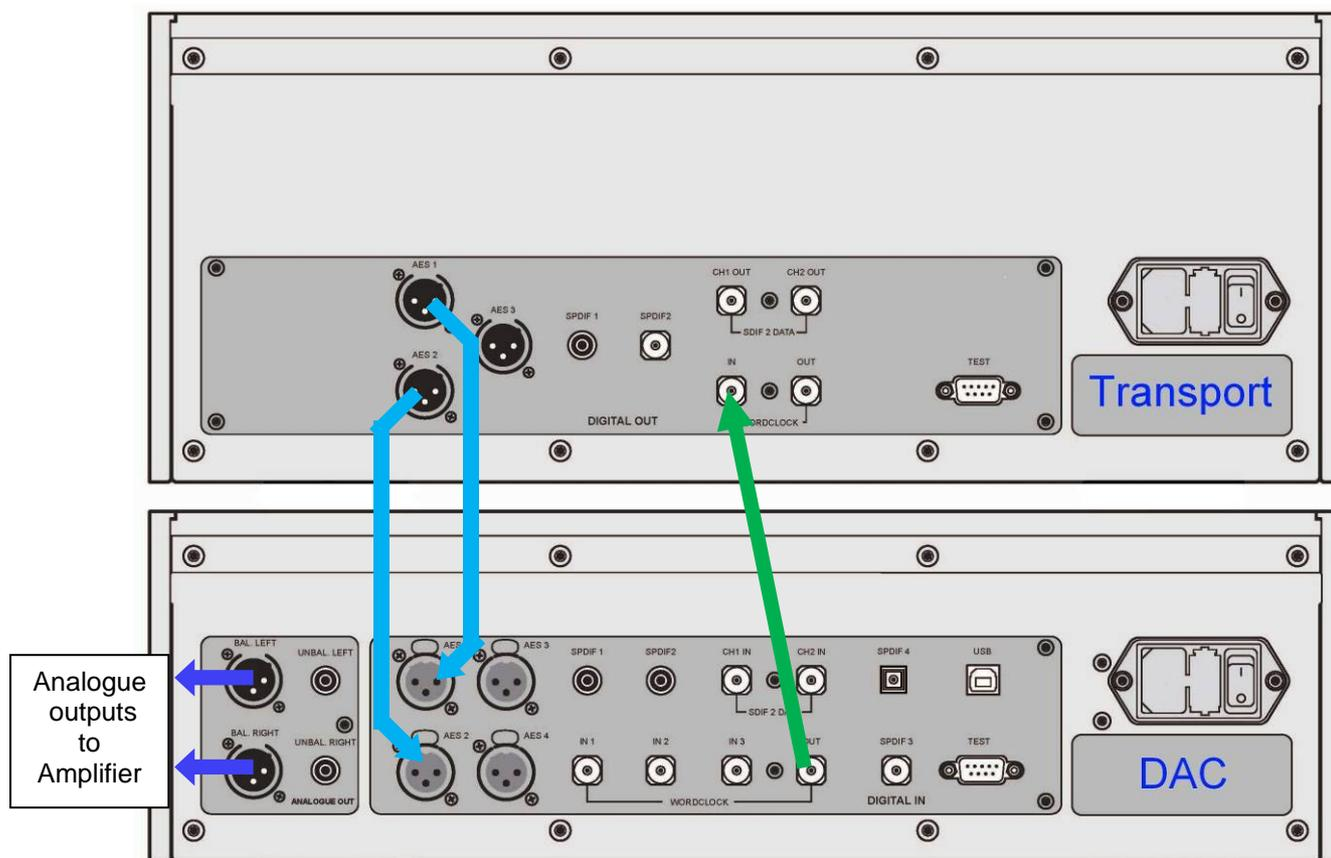

Figure 3 – Using the Vivaldi Transport with the DAC in Master Mode



To select **Master Mode**, open the DAC's menu, navigate to the **Settings > Sync Mode** menu page. The button sequence is: **Menu**, **▶**, **Menu**, and then use the **Menu** button to select the **Master Mode** icon.

Using a Master Clock in a CD/SACD system

The performance can be improved further by adding a Vivaldi Clock to the system as shown below.

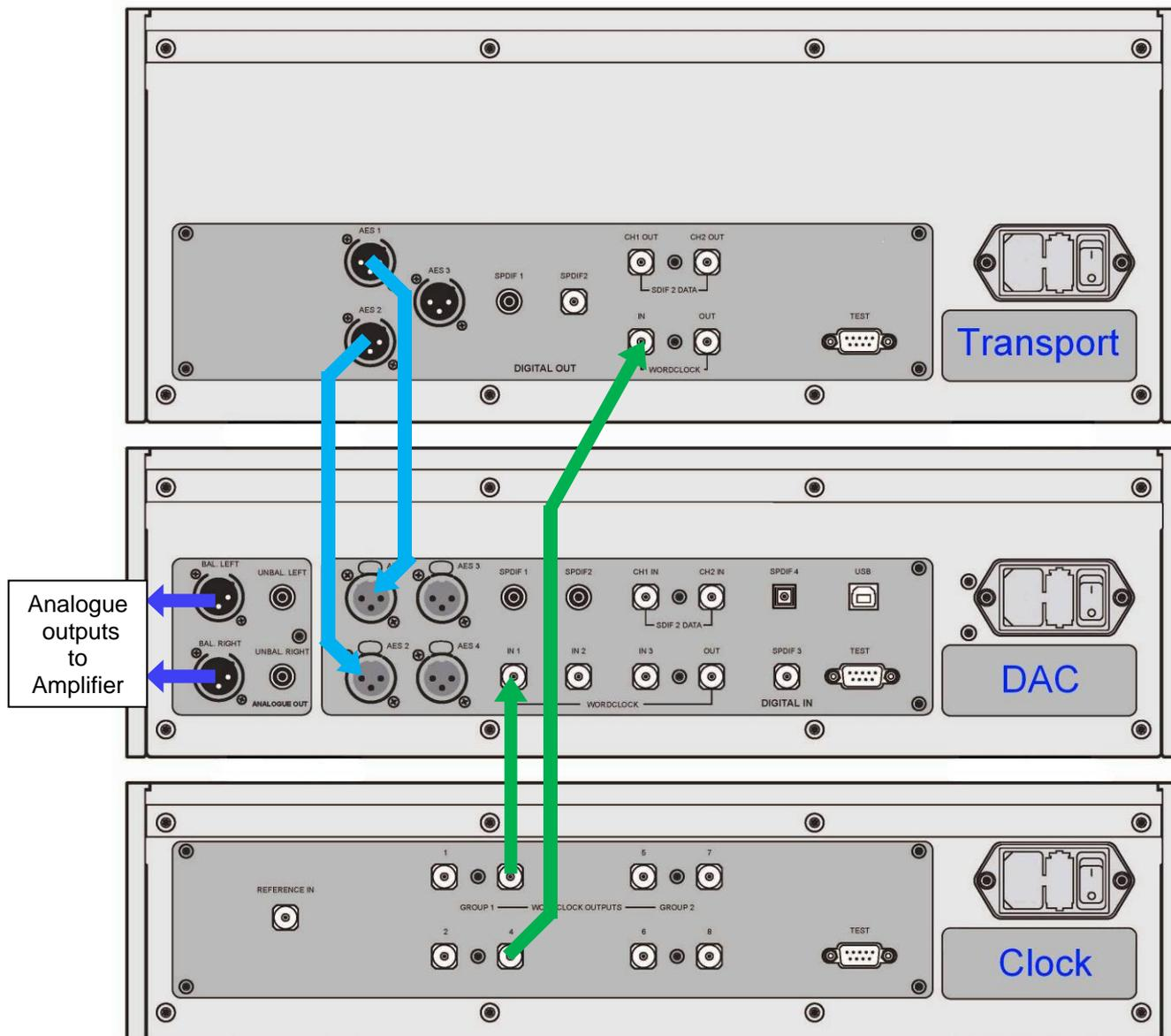

Figure 4 – Using the Vivaldi Transport, DAC and Clock together

- Connect one of the Clock's **Word Clock Group 1 Outputs** to the **Word Clock Inputs** of the Transport and DAC.
- Use the Clock's **Freq1** button to set the Group 1 Outputs to **44.1kHz**, to suit the CD Transport.



To sync the DAC to **Word Clock 1**, open the menu, navigate to the **Settings > Sync Mode** menu page. The button sequence is: **Menu**, **▶**, **Menu**, and then use the **Menu** button to select the **Word Clock 1** icon.

The system will re-lock and un-mute.

Please consult the Vivaldi Clock manual for more information on using a Master Clock.

Please consult the Upsampler manual if your system includes a Vivaldi Upsampler.

The next step is crucial – sit back and enjoy the music.

A full Vivaldi system

The Vivaldi's clocking system has been designed to be very comprehensive to cope with multiple sample rates with a mixture of clocked and un-clocked sources. This applies particularly to streaming computer audio files with different sample rates, or using an Upsampler with a variety of output sample rates.

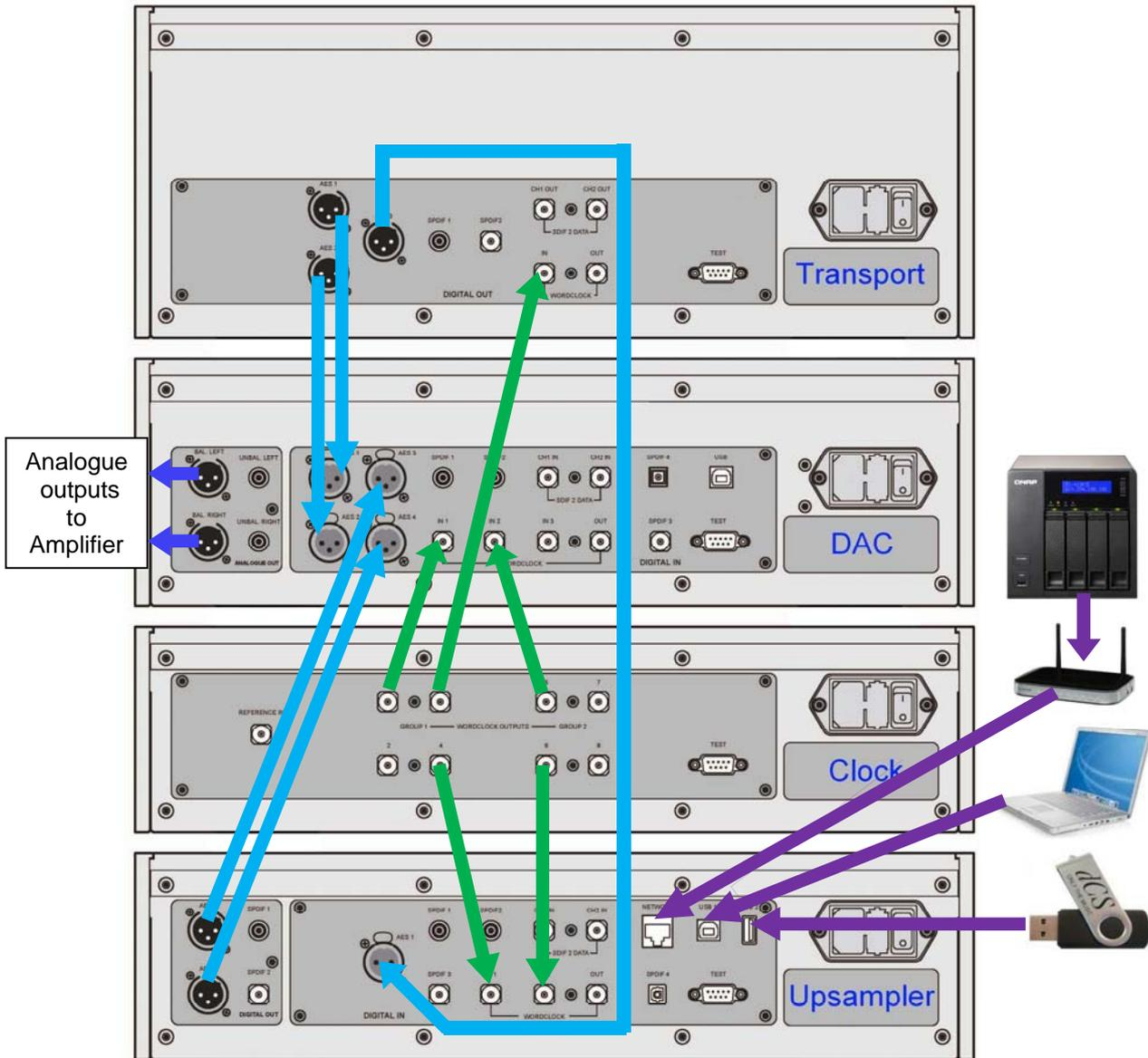

Figure 5 – A 4-box Vivaldi system plus computer audio sources

The system shown above makes excellent use of the Vivaldi's facilities. The Upsampler can be sourced from the Transport, a PC, a NAS drive, an iPod/Phone/Pad or a USB flash drive. The multiple clock connections (shown in green) ensure that the DAC and Upsampler can always access a suitable clock, despite changing file sample rates and changing Upsampler output rates.

The Vivaldi Master Clock has 2 Groups of outputs, each of which can be set to any of 6 standard clock frequencies. The DAC and Upsampler have 3 and 2 Word Clock inputs respectively, to ensure they can have access to a suitable clock despite changing sample rates in the system.

- Set Master Clock **Freq1** to **44.1kHz** and **Freq2** to **48kHz**.
- Connect one of the **Clock Group 1** outputs (44.1kHz) to the **Word Clock Input** of the Transport – it will automatically sync.
- Connect one of the **Clock Group 1** outputs (44.1kHz) to the DAC's **Word Clock In1** input and one of the **Clock Group 2** outputs (48kHz) to the DAC's **Word Clock In2** input.
- Connect one of the **Clock Group 1** outputs (44.1kHz) to the Upsampler's **Word Clock In1** input and one of the **Clock Group 2** outputs (48kHz) to the Upsampler's **Word Clock In2** input.



Set the DAC and Upsampler **Sync Mode** menu pages to **Auto**. Remember that this must be set separately for each active input.

- Connect the Upsampler's **AES1+2** output to the DAC's **AES3+4** input.
- Connect the Transport's **AES1+2** output to the DAC's **AES1+2** input.
- Computer audio sources as required can be connected to the Upsampler's Asynchronous USB interfaces and a NAS drive may be connected via a router to the Upsampler's Network input (also Asynchronous). Please see the Upsampler manual for more information.
- Set the Clock's **Settings > Dither** menu pages **On** or **Off** as you prefer.

Advanced options

Customising the input configuration

The Vivaldi DAC's inputs can be renamed to suit your particular system using a computer running a terminal emulator program. The Vivaldi Upsampler has the same feature. The procedure using a Windows PC with TeraTerm is described here, but other programs such as PuTTY or ZTerm can be used. If you have difficulty with this, please ask your Dealer for help.

- Power up the DAC and a Windows PC.
- If necessary, download Tera Term from <http://en.sourceforge.jp/projects/ttssh2/releases/> and install it on your PC. (If the link is broken, please search for the latest version of Tera Term online.)



Set the DAC's **Settings > RS232** menu page to the **T**ext option.

- Use a USB-to-RS232 adapter cable to connect the DAC's **Test** port to one of the PC's USB ports.
- Run ttermpro.exe.
- Click the **Serial** button – Tera Term will automatically select the port connected to the DAC. Click **OK**.
- Click **Setup > Serial Port**, set the **Baud rate** to **4800** and click **OK**.

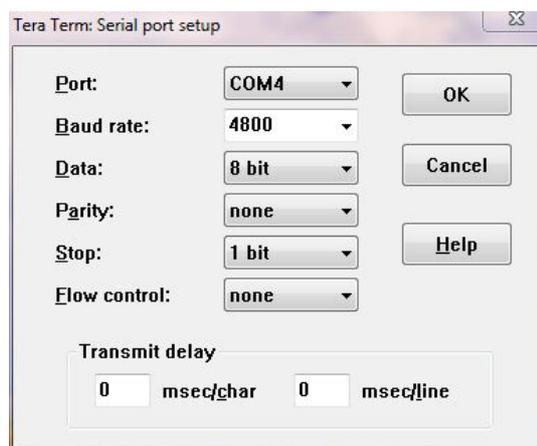

- In the terminal window, type the command: **NAME n = newname** where:
 - **n** is the number corresponding to the standard input name in the list below and

AES1	0	AES2	1	AES1+2	2
AES3	3	AES4	4	AES3+4	5
SPDIF1	6	SPDIF2	7	SPDIF3	8
Toslink	9	SDIF-2	10	USB	11

 - **newname** is the personalised name you want to use for that input, such as CD-SACD, TV or COMPUTER. It can be up to 8 characters long, consisting of:
 - capital letters A-Z, numbers 0-9 or + - / = . : ? ! @ &
- Press **Enter**.

For example:

- to rename the **AES1+2** input to CD-SACD, type: **NAME 2 = CD-SACD** and press enter.
- to rename the **USB** input to COMPUTER, type: **NAME 11 = COMPUTER** and press enter.



Later on, if you want to revert to the standard input names (**AES1**, **SPDIF2**, etc.), select the **Configuration > Reset Input Names** menu page. Your customised input names will be permanently deleted.

Playing MQA files



MQA (Master Quality Authenticated) is an award-winning British technology that delivers the sound of the original master recording. The master MQA file is fully authenticated and is small enough to stream or download.

Visit www.mqa.co.uk for more information.

The MQA logo is a trademark of MQA Limited and is used under licence.

Vivaldi DAC v2.10 onwards performs the final rendering for MQA data.



MQA data that has been partly unfolded by another device (such as the Vivaldi Upsampler or the Network Bridge) will be rendered to the original sample rate. The **MQA** icon will appear on the display, together with the decoded sample rate.



MQA decoding is not possible if the partly unfolded MQA data has been changed. If the MQA logo does not appear when expected, please check that the device performing the first unfold is not processing the data further.

FRONT PANEL

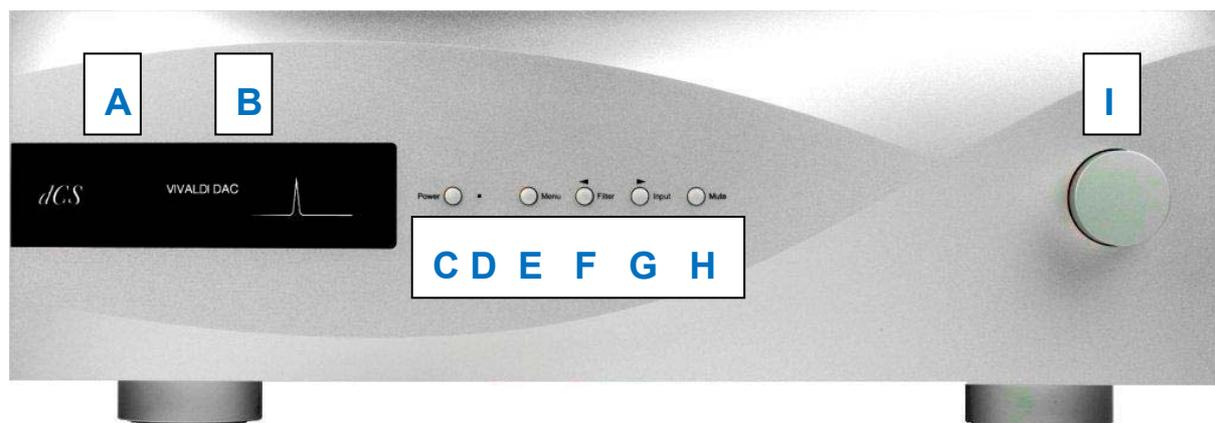

Figure 6 – Front panel

Remote Control Receiver

Aim the remote control handset towards the receiver (A) for best sensitivity.

Display

In normal use, the display (B) is split into 4 areas:

The top left corner usually shows the selected input (e.g. **AES1+2**). While you are changing settings (e.g. Filter), the current setting may be displayed here briefly.

The top right corner shows the locking status, the data format. Some examples are **No Input**, **16/44.1** (the number of active bits and the sample rate), **24/192**, **DSD** or **MUTE**. Between tracks on a CD, the number of active bits is zero, so **0/44.1** may be displayed.

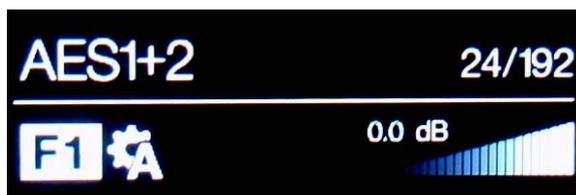

The icons at the bottom left corner are the selected **Filter** (**Filter 1** is shown) and the **Sync mode** (slave to **Audio** is shown). Other icons such as **Phase Invert**, **Channel Swap** or **MQA** appear here when required.

The “staircase” icon gives a visual indication of the **Volume** or **Balance** setting, with the setting shown in text as well (**0.0dB** is shown).

If the DAC is receiving an AES or SPDIF data stream in which the NonAudio flag has been set, the DAC will mute and display **Non Audio**. This happens when the DAC is connected directly to a Vivaldi Transport (v1.10 or later) and a disc is loaded. The volume “staircase” will reappear briefly if the volume setting is changed. The Transport cancels the NonAudio flag when the disc starts playing.

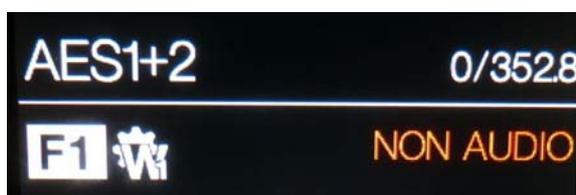

Details of the menu displays are shown in the Menu section on page **28**.



To avoid unnecessary display wear, we recommend switching off or setting the unit to Sleep mode at the end of the listening session.

Power Button

To switch on, ensure the rear panel switch is set to **I** and press the **Power** button (C) on the front panel once. Note that the unit cannot be turned on from the remote control.

To set the unit to sleep mode, press the **Power** button once. The main display will turn off, the LED (D) beside the button will light, and the analogue outputs will mute, but the unit will remain close to running temperature. Press again to return to normal operation.

To switch off, hold down the **Power** button for about 3 seconds until **Switching Off** appears on the display, then release it.

When the menu is open, press the **Power** button to close the menu.

Menu Button

Press the **Menu** button (E) to open the menu, select menu pages and change settings. See the Menu section on page **28** for information on using the menu features.

Filter Button

Use the **Filter** button (F) to select your preferred filter. This is a personal preference and is best done by ear. The choice of filter may depend on the type of music you are listening to.

In PCM mode, the first 4 filters give different trade-offs between the Nyquist image rejection and the phase response. **Filter 1** has the best rejection of (unwanted) Nyquist images and the sharpest roll-off, resulting in the poorest transient response of the four. Filters 2, 3 and 4 have progressively more relaxed image rejection and progressively better transient response. **Filter 2** is often preferred for orchestral music, while **Filter 3** and **Filter 4** are often used for rock music.

If the source data rate is 176.4, 192, 352.8 or 384kS/s, two extra filters are available. **Filter 5** has a Gaussian response (which has no overshoot on transients, with a relaxed roll-off) and **Filter 6** is an asymmetrical type (which features almost no pre-ringing).

There are 2 extra filters for 44.1kS/s operation. **Filter 5** is an asymmetrical design with non-linear phase and no pre-ringing. **Filter 6** is a new sharp filter which has linear phase and pre-ringing. Try them and decide for yourself which you prefer.

While rendering MQA format data, **Filter M1** may be selected in addition to the others. This is the recommended filter for MQA. The MQA filter setting is stored separately as if it were an extra sample rate.

The impulse responses for the six 44.1kS/s filters are shown below. (The filters for other sample rates will have different pulse responses.) The horizontal or time axis is graduated at 100 microseconds per division.

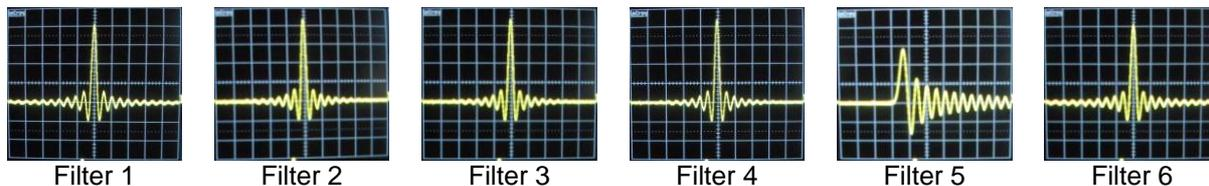

Rotary Control

The Rotary Control (I) usually controls the **Volume** setting. The **Volume** setting changes in 0.5dB steps between 0dB (full volume) and -50dB, in 1dB steps down to -80dB and then mutes below -80dB. When the volume is changed, the volume setting is displayed in large text for a few seconds.



Mosaic Control location: **“Now playing” screen > Volume slider**

When the **Balance** menu page is open or the remote **Balance** button has been pressed, it adjusts the channel **Balance** instead.

Mosaic Control location: **Device > DAC Balance**

While the menu is open, the Rotary Control pages forward and backwards through the menu instead of changing the volume.

REAR PANEL

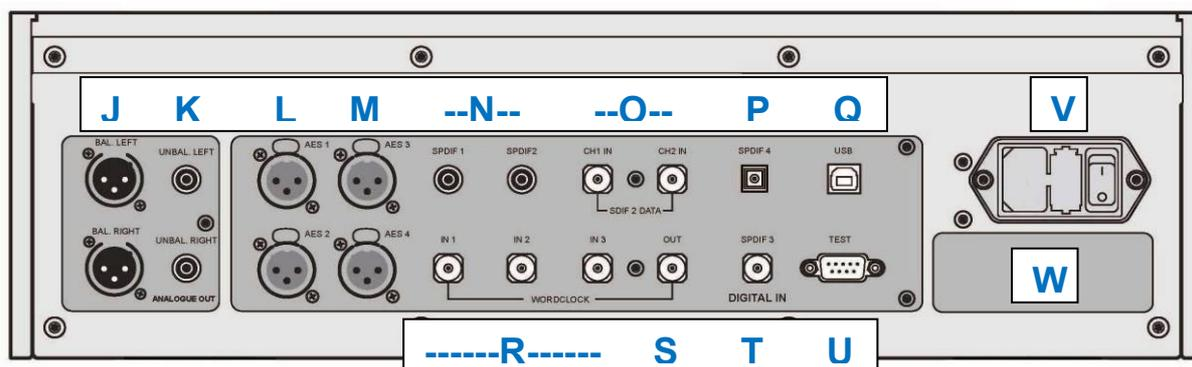

Figure 7 – Rear panel

Analogue Outputs

The unit features independent **Balanced Outputs** (J) on XLR connectors and **Unbalanced Outputs** (K) on RCA connectors. The Left channel outputs are in the top row and the Right channel outputs are on the lower row.

Our **Balanced Outputs** are intended to be connected to true balanced inputs only. They are electronically balanced and floating, so they behave like an audio transformer. This arrangement enhances the rejection of hum and interference picked up by the cable when used with a true balanced input.

Most other DACs use a much simpler circuit that does not offer the same level of performance.

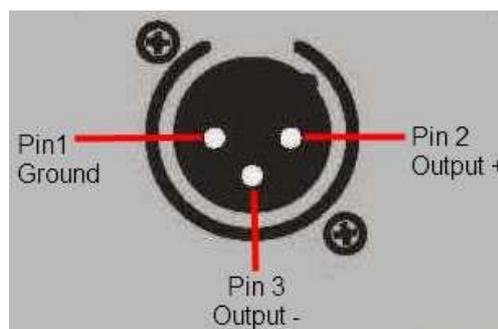

Some amplifier manufacturers provide unbalanced inputs on XLR connectors by leaving pin 3 floating. This arrangement does not work correctly with a floating output stage, resulting in extra noise, unstable signal levels and a “thin” sound. If you want to use the Vivaldi DAC with this type of input, link pin 3 to pin 1 in the cable at the amplifier end. In such cases, we recommend that you use the **Unbalanced Outputs** instead.

AES Digital Inputs

The **AES1**, **AES2** (L), **AES3** and **AES4** (M) inputs can be used individually at sample rates up to 192kS/s, including DoP.

If the **Dual AES1+2** menu page is set to **On** or **Auto**, **AES1+2** can be used together as a **Dual AES** pair at 88.2, 96, 176.4, 192, 352.8 or 384kS/s. **AES3+4** behave in the same way if the **Dual AES3+4** menu page is set to **On** or **Auto**. A Vivaldi Upsampler connected to **AES3+4** can tunnel App commands to the DAC.

Both Dual AES interfaces will also accept *dCS*-encrypted SACD data from the Vivaldi Transport and DoP data (DSD/64 or DSD/128 over PCM) from the Vivaldi Upsampler.



For Dual AES mode to work correctly, the source must actually generate Dual AES data, not just the same single AES data on 2 connectors!

SPDIF Digital Inputs

The unit features 3 electrical SPDIF inputs, labelled **SPDIF1**, **SPDIF2** (N) and **SPDIF3** (T), as well as an optical SPDIF input on a **Toslink** connector (P). Pull out the dust cover before using the **Toslink** input. The electrical inputs will accept sample rates up to 192kS/s including DoP, the **Toslink** input accepts sample rates up to 96kS/s and is not tested or guaranteed at higher sample rates.

SDIF-2 Digital Interface

The **SDIF-2** interface will accept either SDIF-2 PCM data at sample rates up to 96kS/s, or SDIF-2 DSD data. The unit automatically detects the data format and sets the correct mode. The interface consists of two data inputs labelled **CH1** and **CH2** (O). Operation in SDIF mode requires that a word clock from the source is connected to the **Word Clock In1, In2** or **In3** connector (R). Note that the interface can fail to lock correctly if the data sample rate changes but the Word Clock does not.

The interface also accepts data in SDIF-3 format (DSD only), but this not tested or guaranteed.

USB Interface

The **USB** interface on a 'B' type connector (Q) will accept PCM data at up to 24 bits / 384kS/s from a Windows™ PC, Apple Mac™ PC or sound server equipped with a suitable USB2.0 interface. The interface will also accept DSD/64 or DSD/128 data packaged in DoP format and decode it as DSD. This interface operates in true asynchronous mode, which makes the Vivaldi DAC immune to clock jitter from the computer / sound server. The DAC uses its own internal clock or locks to the Master Clock connected to one of the **Word Clock** inputs. Feedback through the USB cable to the computer controls the data delivery rate.



We have tested this interface with several common formats running on Windows™ 10, Windows™ 8.1, Windows™ 7, and Apple Mac™ OSX 10.11 with various PCM streaming programs but we cannot accept responsibility for correct operation with all source devices, operating systems or software.



The **USB** interface is designed to work with a computer or sound server. Nothing useful will happen if you connect the interface directly to an MP3 player or a flash drive. The Vivaldi Upsampler does not support this mode.



The **Settings > USB Class** menu page can set the interface to Class 1 (up to 96kS/s without a special driver) or Class 2 (up to 384kS/s, a special driver is not required for OSX 10.6.3 onwards, the dCS USB Class 2 Driver 2018 is required for Windows).



If you have updated your DAC software and want to use the USB port in Class 2 mode with a Windows PC, un-install any earlier version of the Driver from your PC, and install the 2018 version (see page **11**).

Word Clock Inputs and Output

Each of the three **Word Clock In** connectors (R) will accept standard word clock from the source equipment or a master clock at 32, 44.1, 48, 88.2, 96, 176.4 or 192kHz. The clock frequency **MUST** be an exact multiple of the data rate, otherwise the system will not lock. Use the **Settings > Sync mode** menu page to lock the selected input to the selected external word clock. The source **MUST** be locked to the same clock, otherwise the system will not be locked and periodic clicks or other undesirable noises or dropouts will be heard on the outputs.

Each of the **Word Clock Inputs** may be used individually, but to make operation easier, the *Vivaldi* DAC's **Sync mode** menu page features an **Auto** mode. In this mode you can connect a 44.1, 88.2 or 176.4kHz word clock to **Word Clock In1** and a 48, 96 or 192kHz word clock to **Word Clock In2**. With a source connected to another feed from the same Clock, the DAC can select the correct clock frequency.

Word Clock In3 is primarily intended to be connected to the Upsampler's **Word Clock Out** to improve performance with sources that do not have a Word Clock input.

When the unit is set to Master mode, the DAC uses its internal clock instead of locking to the data or one of the **Word Clock Inputs**, then the **Word Clock Out** connector (S) carries a word clock at the same rate as the single-wire input rate. This **MUST** be connected to the source equipment, so that the system can lock.

Word clock is used for synchronisation only, it does not carry digital data.

Test interface

The **Test** interface (U) is an RS232 interface two modes, set by the **Settings > RS232** menu page.

- **B**inary mode is used to remotely control the unit during automated production testing at *dCS*.
- **T**ext mode is for use with a household automation system. If you would like to use this mode, please download the list of remote control commands from www.dcsLtd.co.uk.

The interface is designed to be used with a “straight through” cable, wired pin 1 to pin 1, etc.

The pin connections are:

- Pin 2 – *dCS* unit transmit
- Pin 3 – *dCS* unit receive
- Pin 5 – ground
- Shell – cable screen & drain wire

Mains inlet

Power is connected via a standard IEC320 connector (V), protected by a fuse and isolated by a 2-pole power switch.

Label

The label (W) states the unit's serial number and the nominal voltage to which the unit is set. It is important to quote the serial number if you need assistance.

THE MENU

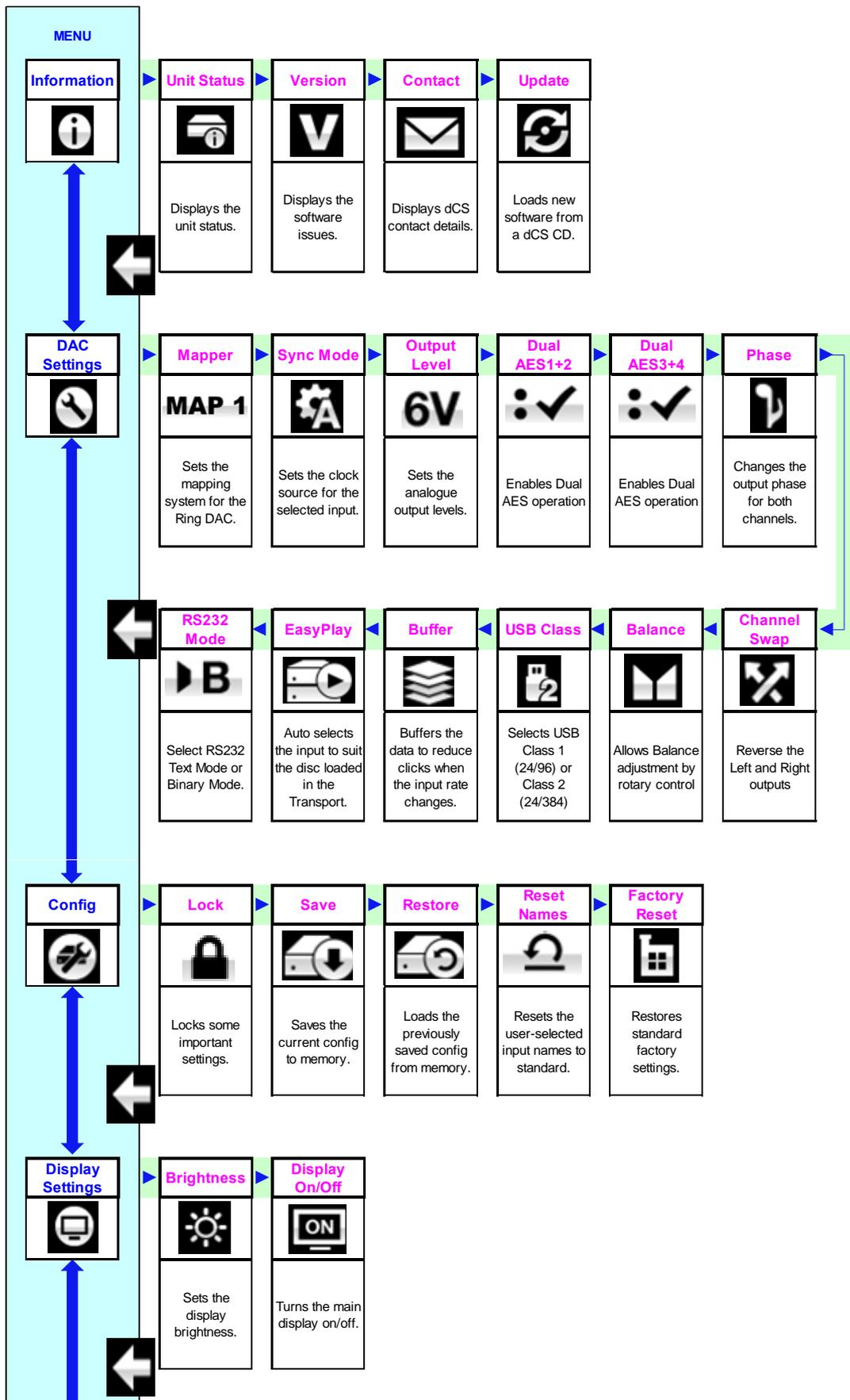

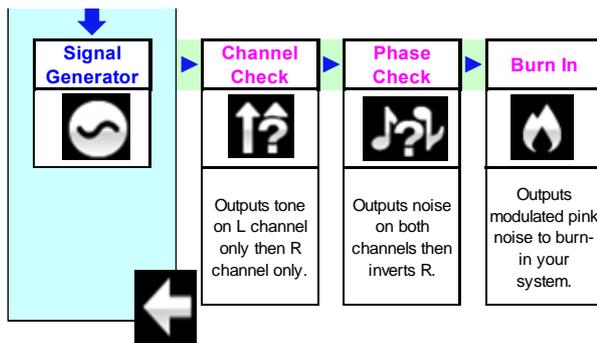

Figure 8 – The menu sequence

Using the Menu

The menu gives the user access to a range of additional features. It also allows new features and performance enhancements to be added later by software updates.

The menu is controlled by four buttons.

- Press the **Menu** button to open the menu or select a setting.
- Press the ► button to page forward through the menu.
- Press the ◀ button pages backward through the menu.
- Press the **Power** button to close the menu or just wait 10 seconds.
- While the DAC's menu is open, the Rotary Control pages forwards or backwards.



Use the Menu Guide sheet to help you find the right menu page.

Each unit in the range has either four or five top-level menu pages:



The **INFORMATION** menu gives unit set-up details, software issues, serial number and contact details.



Each model has a **different SETTINGS** menu, which allows you to set some features that are not directly accessible from the front panel.



The **CONFIGURATION** menu allows you to lock important settings, save a standard setup and reset the unit.



The **DISPLAY SETTINGS** menu is used to adjust the display.



The **SIGNAL GENERATOR** menu (featured on the Transport, Upsampler and DAC only) contains test and set-up routines.

Use the ► button to move the blue highlight to the menu you want, then press the **Menu** button to select it. The next menu level down is displayed. Use the ► button to move the highlight to the menu page you want, then press the **Menu** button to display the information or change the setting.



Select the return icon to go back to the previous menu level.

INFORMATION Menu

Unit Status



The **Unit Status** page displays:

- The long version of the serial number, including the hardware configuration code.
- Each input and the sample rate detected on that input.
- Each Word Clock input and the clock frequency detected on that input.
- Internal temperature°C.

Use the ◀ ▶ buttons to scroll up or down the list. This page does not time out, press the **Menu** button to exit.

Mosaic Control location: **SETTINGS > SUPPORT > Status**



If your system is not behaving as you expect, the **Unit Status** pages can help you find set-up or connection errors.

Version



The Version page displays the software versions loaded in the unit. Please have this information ready if you contact your dealer for any reason:

- Control Board: 2.1x (this is the main software version)
- Front panel: 2.1x

This page does not time out, press the **Menu** button to exit.

Mosaic Control location: **SETTINGS > SUPPORT > Versions**

Contact



The **Contact** page displays dCS web-site URL and support email address. This page does not time out, press the **Menu** button to exit.

If you have any difficulty, please contact your dealer for help first.

Update



The **Update** feature allows you to load new software into your system from a computer streaming bit-perfect data via the USB interface. Please contact your dealer or distributor for a link, download the file to your computer and unzip it. Inside, you will find a large WAV file and PDF instruction document. Follow the instructions to load the WAV file via the DAC's USB interface.



If you accidentally start an Update, do not worry. The unit will automatically detect it is not receiving updated software and will abort the process. The software will not have been changed.

SETTINGS Menu

Mapper

The **Mapper** controls the way in which data is presented to the Ring DAC™ core. There are now 3 Mapper options:

MAP 1 **Map 1** is the new default mapper. It drives the Ring DAC™ core at either 5.644 or 6.14MHz.

MAP 2 **Map 2** is the classic mapper design, used on all 1.xx versions of the Vivaldi DAC and based on the design used by dCS for the last 20+ years. It drives the Ring DAC™ at 2.822 or 3.07MHz.

MAP 3 **Map 3** is an alternative design, which also runs at 5.644 or 6.14MHz.

Our listening tests concluded that **Map 1** gives the most musical results, but you have a choice.

Mosaic Control location:

SETTINGS > AUDIO > dCS Vivaldi DAC > dCS Processing Platform > DAC Mapper

Sync Mode

This page sets the clocking for the digital input that is currently selected. The DAC remembers the **Sync Mode** setting separately for each digital input. The options are:



Audio – The DAC extracts the clock from the data stream connected to the selected digital input and locks to it. Use this setting for sources that do not have a suitable Word Clock input. This arrangement does NOT give the best jitter performance or the best sound quality. The **SDIF-2** and **USB** inputs cannot be set to **Audio Sync**.



Master – The DAC uses its own stable clock while the **Word Clock Output** carries a clock at the same rate as the incoming data, so that the source can lock to the DAC. For correct master mode operation, the source equipment MUST be locked to the DAC. This is the recommended setting if you have a Vivaldi Transport, but not a Vivaldi Clock. The **SDIF-2** input does not support this mode.



Universal Master Mode – This mode is for use with a Vivaldi Upsampler and a computer audio source, where no Master Clock is available. The DAC generates a 38.4kHz clock at the **Word Clock Output**, which must be connected to one of the Upsampler's **Word Clock Inputs**. The Vivaldi Upsampler (v1.10 or later) can lock to the 38.4kHz clock while receiving data at any standard rate.

Note that the Scarlatti and Paganini Upsamplers do not support this mode.



Word Clock 1-2 Auto – This mode is designed for easy operation with a Vivaldi Clock, Upsampler and computer, where the data rate may keep changing. Connect the **Word Clock In1** input to a Clock output set to 44.1 or 88.2 or 176.4kHz and connect the **Word Clock In2** input to a Clock output set to 48, 96 or 192kHz. The Upsampler's Word Clock inputs should be connected similarly. When the sample rate changes, the DAC and Upsampler will automatically select a Word Clock frequency that is synchronous with the data. The selected word clock input is displayed. This mode is not available for the **SDIF-2** input.



Word Clock 1 – The DAC locks to an external clock connected to **Word Clock In1**.



Word Clock 2 – The DAC locks to an external clock connected to **Word Clock In2**.



Word Clock 3 – The DAC locks to an external clock connected to **Word Clock In3**.



If the DAC cannot find a word clock that is synchronous with the data on the selected AES or SPDIF input, it will default to **Audio** sync and display the “Bad Clock” icon.

Mosaic Control location: **SETTINGS > DEVICE > DAC Sync Mode**

Output Level

6V

This page sets the full scale output level to **6V**, **2V**, **0.6V** or **0.2V** rms to allow you to match the DAC’s output level to your amplifiers, speakers and room.

2V

When you set up your system, choose the **Output Level** setting that gives a comfortable listening level with the **Volume** set between **-10dB** and **-30dB**. The difference between two adjacent settings is about 10dB.

.6V

The lower settings are intended to prevent accidents when driving the amplifiers directly with unexpectedly high volume levels.

.2V

Mosaic Control location: **SETTINGS > AUDIO > dCS Vivaldi DAC > Output**

Dual AES1+2

This setting allows the **AES1** and **AES2** inputs to be used together to accept PCM data at high sample rates (88.2, 96, 176.4, 192, 352.8 or 384kS/s or DSD) from a Dual AES source. Note that a source with two AES outputs might not actually produce Dual AES data! The settings are:



- **Off** – Dual AES mode is disabled. Both inputs accept single AES data.



- **On** – Dual AES mode can be manually selected using the **Input** button or the remote control.



- **Auto** – The unit detects the format flags in the digital data and automatically sets the **AES1** & **2** inputs to Single AES or Dual AES mode as required. This is the usual setting. Note that if the format flag in the data is wrong, you will need to manually select the correct setting.

Mosaic Control location: **SETTINGS > DEVICE > DAC AES 1/2 Dual AES**

Dual AES3+4

This page operates in the same way for the **AES3** & **AES4** input pair.

Mosaic Control location: **SETTINGS > DEVICE > DAC AES 3/4 Dual AES**

Phase



This page changes the phase of all the analogue outputs from normal phase...



...to inverted phase, to correct for absolute phase errors on recorded music.

Mosaic Control location: **“Now playing” screen > **

Channel Swap



Swaps the channels from normal...



...to swapped to correct a connection error. Correct the error and change back to normal. **Channel Swap** does not affect the **Channel Check** feature.

Mosaic Control location: **SETTINGS > SYSTEM TEST > DAC Channel Swap**

Balance



The operation of the rotary control changes to adjust the balance. Each channel can be varied from 0dB to -6dB in 0.1dB steps, then mute ($-\infty$) below that. **Balance** adjustment ends after this menu page closes or the **Menu** button is pressed. Most owners use the remote control to adjust the balance.

Mosaic Control location: **SETTINGS > DEVICE > DAC Balance**

USB Class



Set to **Class 1**, the **USB** interface will operate with Mac PCs running OSX 10.5 onwards or Windows PCs at sample rates up to 96kS/s.



Set to **Class 2**, the **USB** interface will operate with Mac PCs running OSX 10.11 onwards at sample rates up to 384kS/s. **Class 2** operation with Windows PCs requires that the dCS USB Class 2 Driver 2018 is loaded.

After selecting a different USB Class, wait for 10 seconds while the USB software is re-loaded.



Note that the **USB** interface will not be detected by the computer if the unit is set to **Class 2** and a suitable driver is not available.

Mosaic Control location: **SETTINGS > DEVICE > DAC USB Audio Class**

Buffer



Set to **On**, the digital data is delayed before being presented to the Ring DAC – this is the usual setting. The delay is 0.72 seconds with 44.1kS/s data, falling to 0.16 seconds with 192kS/s data. The delay gives the DAC time to detect changes in sample rate or clock frequency and mute before the change causes audible clicks or other noises.



The extra delay is not a problem with music, but if the DAC is used with television or video, it may cause the sound to be out of sync with the picture. To reduce the delay, set the **Buffer** to **Off**.

Mosaic Control location: **SETTINGS > DEVICE > DAC Buffer**

EasyPlay



Set to **On**, if the Vivaldi DAC is connected to the Transport's Dual AES output, the action of loading a disc in the Vivaldi Transport causes the DAC to change input to match the disc type.

If the disc is an SACD, the Dual AES input connected to the Vivaldi Transport is selected.

If the disc is a CD, the data stream sourced from the Transport's PCM outputs is selected in the order:

1. The upsampled AES or Dual AES data from the Vivaldi Upsampler.
2. The upsampled Dual AES data direct from the Vivaldi Transport.



With **EasyPlay** set to **Off**, automatic input selection is disabled.

Mosaic Control location: **SETTINGS > DEVICE > DAC EasyPlay**

RS232 Mode



This page sets the RS232 interface to either **T**ext mode for use with 3rd-party control systems or...



...dCS production **B**inary mode, which is intended for factory use only.

CONFIGURATION Menu

Settings Lock



Set to **Locked**, this icon is displayed and the following settings cannot be changed:

- **Mapper**
- **Sync Mode** setting for all inputs
- **Output Level**
- **Dual AES 1+2**
- **Dual AES 3+4**
- **Channel Swap**
- **Balance**
- **USB Class**
- **RS232 Mode**
- **Factory Reset** is disabled



Set to **Unlocked** if you need to change these settings.

Save Configuration



Once the unit is set up the way you want it, select **Save** to store the settings in memory. If you deliberately change the setup later and want to keep it, select **Save** again to store the changes.

Restore Configuration



If the unit settings are accidentally changed, select **Restore** to reload the settings you saved earlier.

Reset Input Names



If the inputs have been renamed from a computer, this page resets them to the original names: **AES1**, **AES2**, etc.

Factory Reset



This page resets the unit to standard settings. These are:

- **Volume** to **-30dB**.
- **Balance** to centre.
- **Input** to **AES1**.
- **Mapper** to **Map 1**.
- **Sync** to **Audio** for all inputs, except
- **USB** sync to **Master**
- **SDIF-2** sync to **Word Clock In1**
- **Filter** to **1** for all sample rates.
- **Dual AES1+2** & **3+4** to **Auto**.
- **Phase** to **Normal**.
- **Output Level** to **2V**.
- **Display** to **On**.
- **Brightness** to maximum.
- **RS232 Mode** to **Binary**.
- **Channel Swap** to **Normal**.
- **Buffer** to **On**.
- **EasyPlay** to **On**.

DISPLAY SETTINGS Menu

Brightness



Set the display **Brightness** to a comfortable level using the ◀ or ▶ buttons.

Mosaic Control location: **SETTINGS > DISPLAY > DAC Display Brightness**

Display On/Off



This page is usually set to **On**.



When set to **Off** and the menu closes, the display will turn off after a few seconds. The display will turn on briefly when a control setting is changed. The display will stay on if the unit is not locked or is muted or while the menu is open.

Mosaic Control location: **SETTINGS > DISPLAY > DAC Display On / Off**

GENERATOR Menu

Channel Check



A routine to test the system for swapped channels. A tone is output on the left channel only while the display shows **Left**, then the right channel only while the display shows **Right**. If these are the wrong way around, the left and right channels are swapped somewhere in your system. This test is not affected by the **Channel Swap** menu page setting.

Mosaic Control location: **SETTINGS > SYSTEM CHECK > Channel Check**

Phase Check



A routine to test the system for phase reversals. Noise is output in phase on both channels while the display shows **In Phase**. Press the **Menu** button, the noise on the right channel is inverted while the display shows **Out of Phase**. The first burst should produce a central image, the second burst should not. If these are the wrong way around, one channel in your system is phase inverted. Press the **Power** button to stop the test and return to the menu.

Mosaic Control location: **SETTINGS > SYSTEM CHECK > Phase Check**

Burn In



A procedure to condition your system. The unit displays **Burn In Caution! Loud**, then outputs modulated pink noise that ramps up slowly in level. Press any button to stop the procedure.



Please ensure that the volume level is reasonable, as careless use of the **Burn In** feature can damage your amplifiers and loudspeakers. dCS will not be liable for such damage.

SPECIFICATION

Converter type	dCS proprietary Ring DAC™ topology.																					
Digital inputs	<p>4x AES/EBU on 3-pin female XLR connectors.</p> <p>Each will accept up to 24 bit PCM at 32, 44.1, 48, 88.2, 96, 176.4 or 192kS/s or DSD/64 in DoP format,</p> <p style="text-align: center;">OR</p> <p>used as Dual AES pairs at 88.2, 96, 176.4, 192, 352.8 or 384kS/s or encrypted DSD or DSD/64 or DSD/128 in DoP format.</p> <p>3x SPDIF on 2x RCA Phono and 1x BNC connectors. Each will accept up to 24 bit PCM at 32, 44.1, 48, 88.2, 96, 176.4 or 192kS/s or DSD/64 in DoP format.</p> <p>1x SPDIF optical on a Toslink connector, will accept up to 24 bit PCM at 32, 44.1, 48, 88.2 or 96kS/s.</p> <p>1x SDIF-2 interface on 2x BNC connectors, will accept up to 24 bit PCM at 32, 44.1, 48, 88.2 or 96kS/s or SDIF-2 DSD (auto-selected). This interface requires a compatible word clock connected to one of the Word Clock Inputs, locked to the data rate.</p> <p>USB interface on a B-type connector, will accept up to 24 bit PCM at:</p> <ul style="list-style-type: none"> • 44.1, 48, 88.2 or 96kS/s when set to USB Class 1 (no driver required). • 44.1, 48, 88.2, 96, 176.4, 192, 352.8 or 384kS/s when set to USB Class 2 (no special driver is required for OSX 10.6 onwards, load the latest dCS USB Class 2 driver for Windows). • Set to USB Class 2, decodes DSD/64 or DSD/128 in DoP format. <p>The USB interface operates in true asynchronous USB mode.</p>																					
Clocking	<p>3x Word Clock Inputs on 3x BNC connector, accept standard word clock at 32, 44.1, 48, 88.2, 96, 176.4 or 192kHz. The data rate can be the same as the clock rate or an exact multiple (0.25x, 0.5x, 1x, 2x, 4x, 8x) of the clock rate. Sensitive to TTL levels.</p> <p>Word Clock Output on 1x BNC connector. In Master mode, a TTL-compatible word clock appears on this output, not temperature compensated. The word clock frequency is either 44.1 or 48kHz, depending on the incoming data rate. In Universal Master Mode, a TTL-compatible 38.4kHz word clock appears on this output, for connection to the Vivaldi Upsampler.</p>																					
MQA	Performs the final rendering of MQA data that has been partly unfolded by another device.																					
Frequency response (set to Filter 1)	<table> <tr> <td>Fs = 32kS/s</td> <td>+0.1/-0.5dB, 10Hz to 15kHz</td> <td></td> </tr> <tr> <td>Fs = 44.1 or 48kS/s</td> <td>+/-0.1dB, 10Hz to 20kHz</td> <td></td> </tr> <tr> <td>Fs = 88.2 or 96kS/s</td> <td>+/-0.1dB, 10Hz to 20kHz</td> <td>-3dB @ >38kHz</td> </tr> <tr> <td>Fs = 176.4 or 192kS/s</td> <td>+/-0.1dB, 10Hz to 20kHz</td> <td>-3dB @ >67kHz</td> </tr> <tr> <td>Fs = 352.8 or 384kS/s</td> <td>+/-0.1dB, 10Hz to 20kHz</td> <td>-3dB @ >100kHz</td> </tr> <tr> <td>DSD/64</td> <td>+/-0.1dB, 10Hz to 20kHz</td> <td>-3dB @ >90kHz</td> </tr> <tr> <td>DSD/128</td> <td>+/-0.1dB, 10Hz to 20kHz</td> <td>-3dB @ >100kHz</td> </tr> </table>	Fs = 32kS/s	+0.1/-0.5dB, 10Hz to 15kHz		Fs = 44.1 or 48kS/s	+/-0.1dB, 10Hz to 20kHz		Fs = 88.2 or 96kS/s	+/-0.1dB, 10Hz to 20kHz	-3dB @ >38kHz	Fs = 176.4 or 192kS/s	+/-0.1dB, 10Hz to 20kHz	-3dB @ >67kHz	Fs = 352.8 or 384kS/s	+/-0.1dB, 10Hz to 20kHz	-3dB @ >100kHz	DSD/64	+/-0.1dB, 10Hz to 20kHz	-3dB @ >90kHz	DSD/128	+/-0.1dB, 10Hz to 20kHz	-3dB @ >100kHz
Fs = 32kS/s	+0.1/-0.5dB, 10Hz to 15kHz																					
Fs = 44.1 or 48kS/s	+/-0.1dB, 10Hz to 20kHz																					
Fs = 88.2 or 96kS/s	+/-0.1dB, 10Hz to 20kHz	-3dB @ >38kHz																				
Fs = 176.4 or 192kS/s	+/-0.1dB, 10Hz to 20kHz	-3dB @ >67kHz																				
Fs = 352.8 or 384kS/s	+/-0.1dB, 10Hz to 20kHz	-3dB @ >100kHz																				
DSD/64	+/-0.1dB, 10Hz to 20kHz	-3dB @ >90kHz																				
DSD/128	+/-0.1dB, 10Hz to 20kHz	-3dB @ >100kHz																				
Residual noise	Better than -113dB0 on 6V setting, 20Hz - 20kHz unweighted.																					
Spurious responses	Better than -105dB0, 20Hz - 20kHz.																					

L-R crosstalk	Better than -115dB_0 , 20Hz - 20kHz.
Output levels	6V, 2V, 0.6V or 0.2V rms on all outputs for a full-scale input, set in the menu.
Balanced outputs	1 stereo pair on 2x 3-pin male XLR connectors (pin 2 = hot, pin 3 = cold). These outputs are electronically balanced and floating, the signal balance ratio at 1kHz is better than 40dB. Output impedance is 3Ω , maximum load is 600Ω (a $10\text{k}\Omega$ - $100\text{k}\Omega$ load is recommended).
Unbalanced outputs	1 stereo pair on 2x RCA Phono connectors. Output impedance is 52Ω , maximum load is 600Ω (a $10\text{k}\Omega$ - $100\text{k}\Omega$ load is recommended).
Size and weight	444mm (17.5") long x 435mm (17.2") deep x 151mm (6.0") high. Allow extra depth for cable connectors. Allow space for air flow around the unit. 16.2kg (35.65lbs).
Power requirements	Internally set to either 100, 115/120, 220 or 230/240V AC, 50/60Hz. Power consumption: 23W typical, 50W maximum. Consumes less than 0.5W when powered down from the front panel.

These specifications are subject to change without notice.

MAINTENANCE AND SUPPORT

Service and Maintenance

dCS audio products are designed not to need regular maintenance, and contain no user serviceable parts apart from the mains fuse. If your unit is damaged in any way, please contact your dealer.

Replacing a Blown Mains Fuse

There is a mains fuse below the power inlet, accessible from the outside of the unit. If the fuse blows, it may be changed by the user. The current consumption of the unit is very low, so it only blows if power surges occur, or there is a fault in the unit. Usually power surges cause no other damage, but if the fuse blows repeatedly on replacement, some other damage will have been done and the unit must be returned to dCS for repair.

Fuse type: 20 x 5mm T 1 amp L fuse



If the fuse should fail, it is essential that it is replaced with one of the same type and rating. Failure to do so could result in damage to the unit, risk of fire or electric shock and will invalidate the warranty. Fuse failure is rare!

Referring to the diagram below, remove the power cable, use your fingernails to catch the two tabs of the fuse holder (A), push them together to release the clips and pull the fuse holder out. Pull out the blown fuse from the lower position (B) and discard it. Either move the Spare Fuse (C) to the lower position or fit one of the fuses from the manual pack. Orient the fuse holder as shown (D) and push the holder back into the power inlet so that it clicks home.

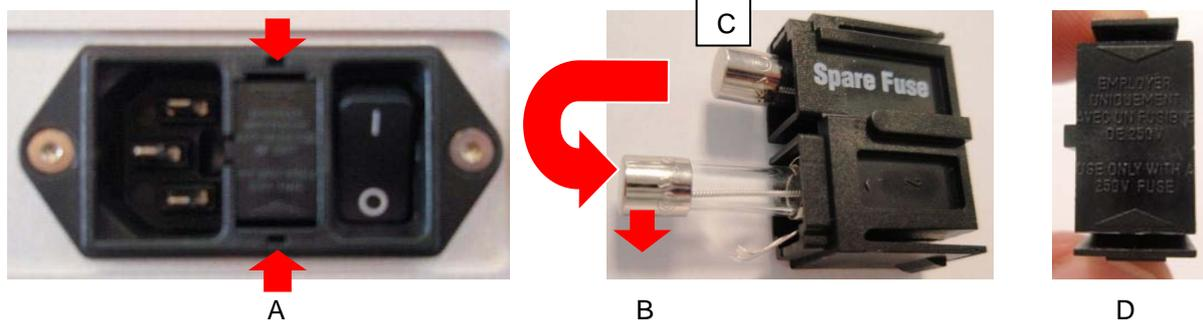

Cleaning the case

The front and back panels of your dCS equipment are machined from very high grade aluminium. Great care has been taken to create the finish of the aluminium throughout the engineering process from the raw solid material to the finished piece.

To remove loose dust or finger marks from the case, we recommend that you use a clean, dry, lint-free cloth.

To restore the finish, we recommend applying small quantities of a lanolin based cleaner, using a clean, dry, lint-free cloth and then wiping off. Do not allow lanolin to collect around the buttons.

Small amounts of glass cleaner containing ammonia may be used to clean other surfaces, but avoid spraying onto the connector contacts.

Limited Warranty

General

dCS warrants this product against defects in materials and workmanship for a period of 3 years from the date the unit was originally shipped from dCS. If the product is purchased and registered with dCS within 6 months of the date the unit was originally shipped from dCS, we will start the warranty on the purchase date. For units registered later than 6 months from the ship date, we will start the warranty from the ship date unless the registration is supported by the original sales invoice. During the warranty period, dCS will repair or, at our absolute discretion, replace a faulty product. Warranty repairs must only be carried out by dCS or our authorised service agents. Please contact your dealer if your unit requires service.

To register this product, either register online at www.dcsLtd.co.uk or complete the **Product Registration** form within 30 days of the sale and return it to dCS. On receipt of the registration, dCS will add your contact details to our customer database. dCS will use this information for warranty purposes only, we will not contact you directly for reasons relating to sales and marketing.

This warranty applies to the original owner, it is not transferable.

Warranty Exclusions

The Warranty does not cover wear and tear.

The Warranty on this product will be void if:

- the product is misused in any way.
- any unauthorised modifications or repairs are carried out.
- the product is not used in accordance with the Operating Conditions stated in this manual.
- the product is serviced or repaired other than by dCS or our authorised service agents.
- the product is operated without a mains earth (or ground) connection.
- the unit is returned inadequately packed.

dCS reserve the right to apply a service charge if a product returned for warranty repair is found to be operating correctly, or if a product is returned without a returns number being issued.

This warranty covers parts and labour only, it does not cover shipping charges or tax/duty.

Our dealers or distributors are NOT authorised to extend the terms of this warranty, dCS cannot accept responsibility for any attempt to do so.

Products re-sold by dCS on a “used” basis may be subject to reduced warranty terms.

Obtaining Service

Should you encounter a problem, contact your authorised dCS dealer for advice, quoting the model, the full serial number, software version number, and giving a detailed description of the fault. Your dealer will advise you fully on actions that need to be taken. When returning a unit, the original packaging should be used to avoid transit damage. Replacement packaging sets may be purchased from dCS.

During the Warranty period, there will normally be no charge for parts or labour.

Operating Conditions

- The supply voltage must remain within +/-10% of the A.C. voltage specified on the back panel.
- The supply frequency must be in the range 49Hz to 62Hz.
- Ambient temperature range: 0°C (32°F) to 45°C (113°F), non-condensing.
- Do not install the unit near heat sources such as radiators, air ducts, power amplifiers or direct strong sunlight.
- If in doubt, the easy test is – the unit is happy to work anywhere a human is.

If you need more help

In the first instance, you should contact your dealer. If they cannot resolve the issue, contact your national distributor.

Manufactured by:

Data Conversion Systems Ltd.
Unit 1, Buckingway Business Park,
Anderson Road,
Swavesey,
Cambridgeshire. CB24 4AE
UK

www.dcsLtd.co.uk

This user manual may be downloaded free of charge from our web-site.

A bound copy of this manual may be ordered from *dCS*.

Software History

dCS products make extensive use of software configurable chips – FPGAs and DSPs. This gives us the ability to update our products to add extra features, update digital interface standards or make performance improvements by loading new software. Occasionally, a hardware upgrade may be necessary also to increase the “capacity” of the electronics, add extra connectors or extra front panel controls.

Please note that not all software updates produce an audible improvement. We recommend that you keep your software up to date. Check the dCS web-site occasionally for news of the latest software updates.



Before requesting a link to the update file, please open the [Info > Version](#) menu page and check the [Control Board](#) version to verify that an update is actually needed.

This manual is for **Vivaldi DAC** software version 2.1x.

Issue 1.00	The first issue.
Issue 1.01	Reliability improvement.
Issue 1.02	Enhanced functionality of "tunnel" commands for App support. RS232 commands added for Sleep, Mute, Output Level and Volume.
Issue 1.10	Configuration menu added, with Settings Lock, Save & Restore Configuration. Buffer and EasyPlay features added to the Settings menu. Inputs that are not connected and active cannot be selected. The USB input accepts 24-bit data at 352.8 and 384kS/s. Universal Master Mode added. The DAC Mutes the outputs when the Non-Audio flag is set in the incoming data. RS232 commands added for Set Sync Mode, set Balance, report Balance setting. Filter settings for 176.4 & 192kS/s are stored correctly at switch off. Performance at 32kS/s corrected. Various minor bugs fixed.
Issue 1.20	When the Non Audio flag is displayed, changing the volume causes the volume display to reappear momentarily. The volume setting behaves correctly when the unit is muted and the volume is changed. More RS232 Text mode commands have been added. The unit will re-lock when the second cable of a Dual AES pair is connected.
Issue 2.00	Two new 6MHz Mappers added. Support for DSD/128 added to USB and Dual AES interfaces. DSD Filter 5 added. Output levels 0.2V & 0.6V rms added. Display changes to full-screen volume when the setting is changed. More RS232 Text mode commands added.
Issue 2.01	0.2V & 0.6V Output Level settings are correctly stored at power down. Improved remote control via the Upsampler / Vivaldi 2.0 app.
Issue 2.02	Reduces the locking time, particularly after a sample rate change. Adds compatibility with a newer hardware version (no performance changes). Corrects a minor Display On/Off bug. Corrects a minor bug related to the 0.2V output setting.
Issue 2.10	Adds final rendering of MQA data that has been unfolded by another device. MQA filters added. Universal Master Mode locking reliability improved. DSD Filter 5 is remembered at power down.
Issue 2.11	Improves click performance and corrects Universal Master Mode.

INDEX**A**

AES input..... 10, 25

Bbalance 33
buffer..... 33
burn in..... 36**C**cables 8
channel check..... 36
channel swap..... 33
cleaning 39
configuration
 restore 35
 save..... 35
configuration menu 35
contact 30**D**display..... 21
display brightness..... 36
display menu 36
display off..... 36
Dual AES 32
Dual AES input 9, 25**E**

easyplay..... 34

Ffeet..... 6
filter button 22
front panel..... 21
full system..... 17
fuse, replacing 39**G**

generator menu 36

Iinformation menu 30
input
 AES 10, 25
 Dual AES 9, 25SDIF-2..... 10, 26
SPDIF 10, 26
Toslink..... 26
USB..... 11, 26
word clock..... 10, 16, 27
input button..... 23
input selection..... 9**L**

lock 35

Mmains inlet 27
mapper 31
master clock 16
master mode..... 31
menu..... 28
 configuration 35
 display 36
 generator..... 36
 information 30
 settings..... 31
 using 29
menu back button 22
menu button..... 22
menu forward button 23
Mosaic 5
MQA 20, 22
mute button..... 23**O**operating conditions 40
output..... 25
 analogue 14, 25
 word clock..... 15, 27
output level 14, 32**P**PC setup..... 12
phase..... 32
phase check 36
positioning 6
power button..... 22
power off..... 22
power up..... 8
preamplifier..... 14**R**rear panel 25
remote control 21
rename inputs..... 19
reset..... 35
reset input names..... 35
restore configuration..... 35
RS232..... 27, 34**S**safety 6, 7
save configuration 35
SDIF-2 input 10, 26
serial number..... 27
service 39
settings menu 31
setup guide..... 8
sleep 22
software 30, 42
SPDIF input 10, 26
specification..... 37
status 30
sync mode 15, 31**T**

Toslink input 26

Uuniversal master 31
update..... 30, 42
USB 33
 class..... 11
 Windows driver 11
USB input 11, 26**V**voltage 27
volume control 24**W**wake 22
warranty..... 40
word clock 27, 31